

TOH: TBD

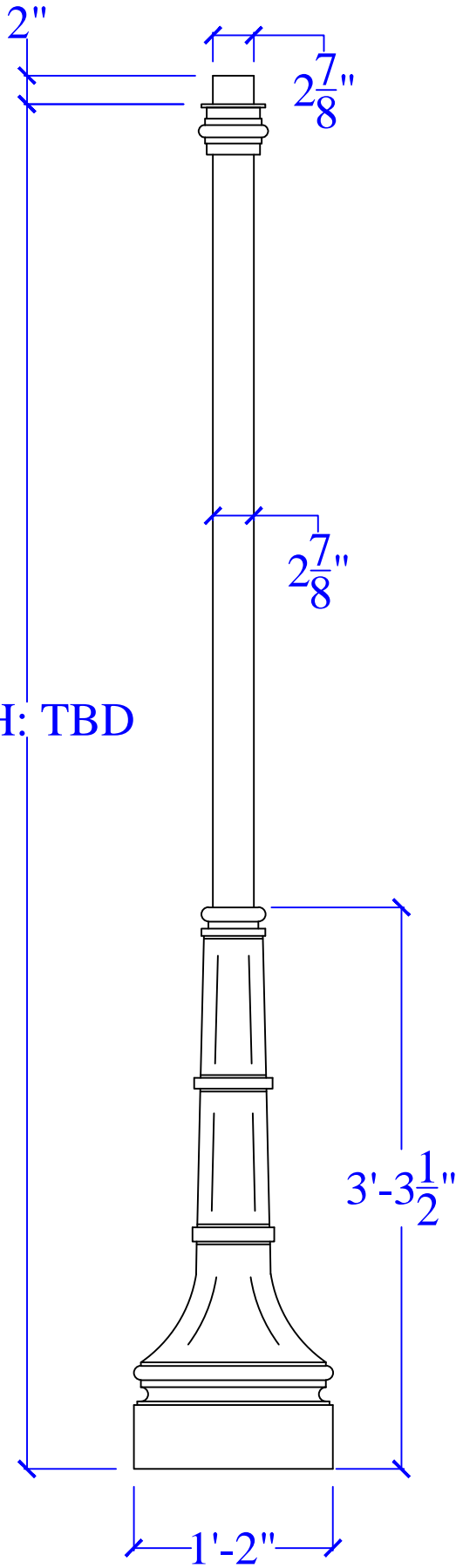

SPECIFICATION SHEET

COPYRIGHT 1994 TO CURRENT YEAR, CHARLESTON LIGHTING & MANUFACTURING, INC. (CLM).
ALL DESIGNS, DRAWINGS, MODEL NUMBERS, AND LANTERN DESIGNATIONS ARE THE SOLE AND EXCLUSIVE PROPERTY OF (CLM) AND SHALL NOT BE DUPLICATED IN WHOLE OR PART WITHOUT THE WRITTEN CONSENT OF (CLM).

CHARLESTON LIGHTING AND MANUFACTURING, INC. (CLM)

212 E. I-65 SERVICE ROAD N. MOBILE, ALABAMA 36607
PHONE: (251) 478-0072 FAX: (251) 471-5945
WWW.CHARLESTONLIGHTING.COM WWW.FAUBOURGLIGHTING.COM WWW.CHARLESTONGASLIGHT.COM

LIGHT:	DATE:	APP.BY:	J.D.
BRACKET: LS-500			REV.