

STANDARD 4" ROUND OR SQUARE PANCAKE BOX WITH HANGAR BAR. USE PROPER ANCHOR BOLTS/LAG BOLTS TO SECURE.

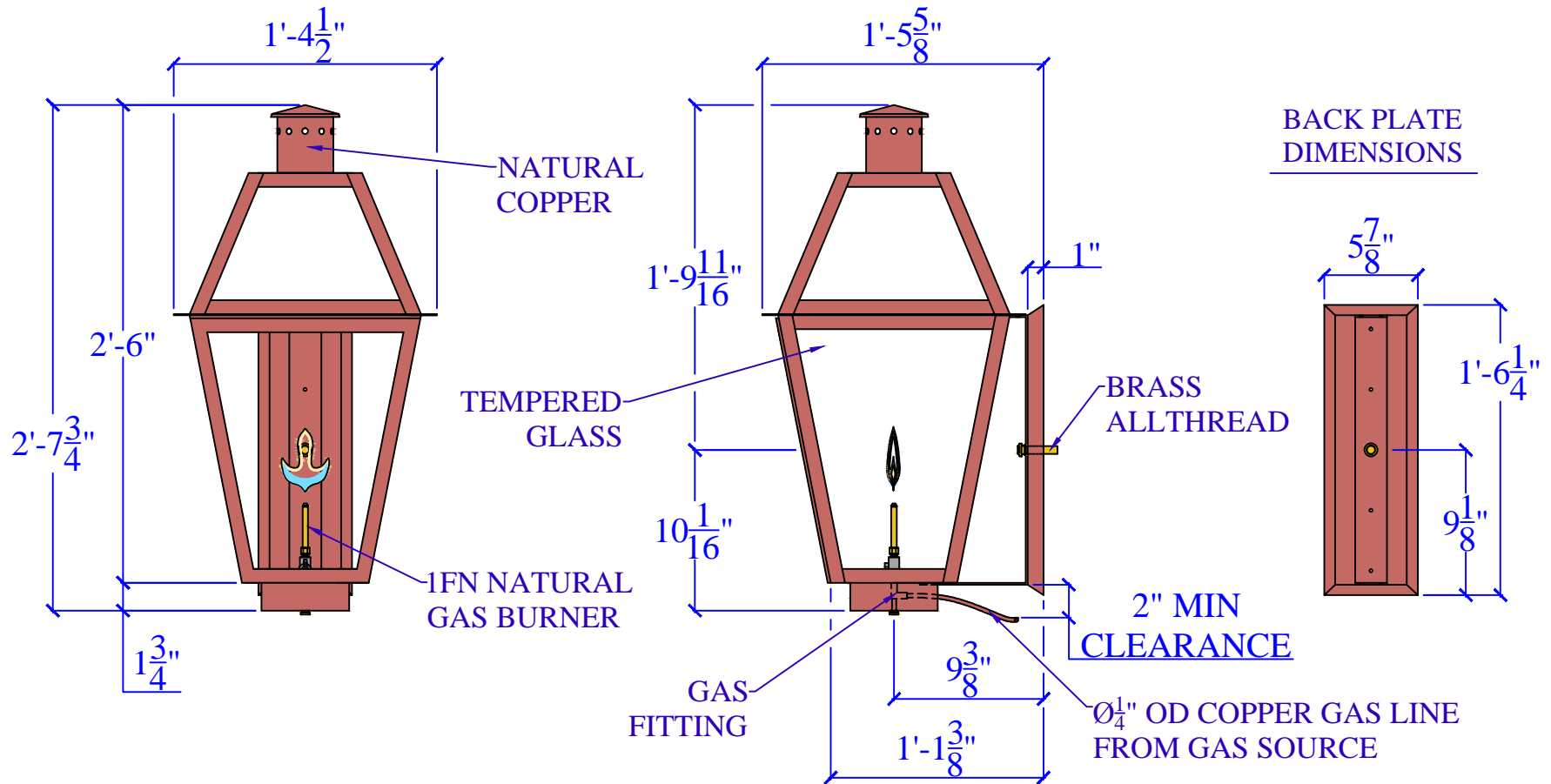

CHARLESTON LIGHTING AND MANUFACTURING, INC. (CLM)

SPECIFICATION SHEET

212 E. I-65 SERVICE ROAD N. PHONE: (251) 478-0072 FAX: (251) 471-5945 MOBILE, ALABAMA 36607
 WWW.CHARLESTONLIGHTING.COM WWW.FAUBOURGLIGHTING.COM WWW.CHARLESTONGASLIGHT.COM

COPYRIGHT 1994 TO CURRENT YEAR, CHARLESTON LIGHTING & MANUFACTURING, INC. (CLM). ALL DESIGNS, DRAWINGS, MODEL NUMBERS, AND LANTERN DESIGNATIONS ARE THE SOLE AND EXCLUSIVE PROPERTY OF (CLM) AND SHALL NOT BE DUPLICATED IN WHOLE OR PART WITHOUT THE WRITTEN CONSENT OF (CLM).

LIGHT:	FAU 1006 30" - 1FN - 6C-C	DATE:	APP.BY:	J.D.
BRACKET:	6C-C - H30" W16-1/2"		REV.	